

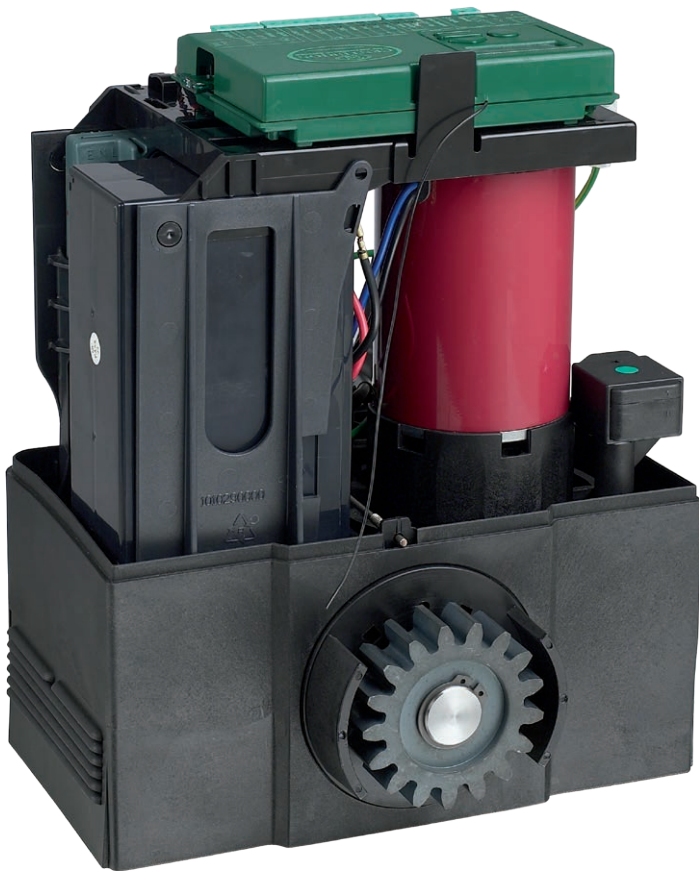

DOMESTIC AND LIGHT-INDUSTRIAL SLIDING GATE OPERATORS

Tried, tested and perfected.
Faster, smarter and easier to set up.



D5-EVO AND D5-EVO LOW-VOLTAGE

They say you can't improve upon perfection. Well, they obviously haven't seen the **D5-Evo**.

One of the most durable and reliable motors ever made, the legendary D5 is renowned the world over. Many years later, old 'tried and tested' gets perfected. We borrowed what we learned from the D10 and applied it to the **D5-Evo**.

Incorporating a 12V version of the D10 controller, the **D5-Evo** also offers a wide range of useful features, which includes ChronoGuard timer functionality (a world first).

Faster, smarter and easier to set up, old faithful even got a facelift and now looks more like its D10 cousin.

Hard as nails and loyal to the end, you can sleep easy, knowing that our **D5-Evo** is on guard.

You can even enjoy the amazing features and functionality of our flagship motor if you don't have mains power at your gate - thanks to the **D5-Evo Low-Voltage**. Simply connect a transformer to this cost-effective model's included rectifier, and enjoy the freedom of fully DIY gate automation! No expensive high-voltage cable runs, no costly isolators, no sweat!

MAIN FEATURES

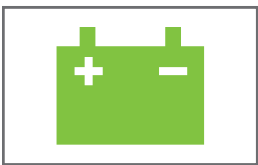

Battery backup

We pioneered power failure protection in gate motors. So in line with all our other motors, the **D5-Evo** carries on guarding your entrance even when the lights go out.

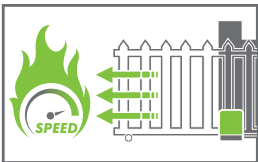

All-important speed

The original D5 made a mark for itself being a quick motor, opening the gate swiftly when you arrive at your entrance. The **D5-Evo** is now that little bit faster, opening your average four metre gate in less than twelve seconds, adding even more security and convenience.

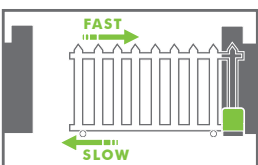

Open it the way you like it...

Rapid opening but a more tempered closing just in case a loved one is in the way, that's the sort of sophistication in motor control you can expect from the **D5-Evo**. Added to this, you can vary the acceleration and deceleration of your gate and make it move so smoothly it will do so for many years to come.

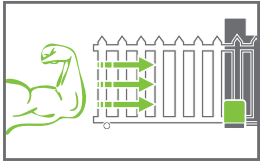

Pushes like a mule

Such a compact package but such a potent push force, it will reliably move almost any gate weighing up to 500kg and do it for a very long time.

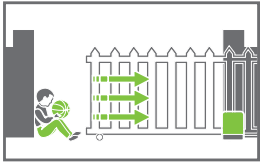

Wide awake all the time!

Incorporating the tried and tested DOSS position control system of its predecessors, the D3 and D5, the **D5-Evo** moves open and closed accurately, stopping in just the right spot each and every time. It's also wide awake to any obstruction that might cross its path, ensuring safe and sensitive anti-crushing protection.



It will turn heads

The **D5-Evo** takes on a new and more attractive look compared to the original D5. It's nice to know that even your trusty gate guard will turn heads.



Plug and play

The LCD-based controller makes child's play of setting up the gate. It is literally plug and play - the **D5-Evo's** controller does all the thinking for you.



It's got it all

What a pleasure to click through an almost endless list of really useful feature: from multiple Modes of Operation, gate operating parameters, Pillar Light control with Pre-flash, Alarm functions, Positive Close Mode and Real Time Clock and Calendar to enable time-based features, to helpful diagnostic feedback. It stops just short of making the coffee!



Forever yours

We know that this compact companion will serve you well - year, after year, after year. So just like all other CENTSYS products, your beautiful **D5-Evo** motor also comes with an industry-leading 24 month warranty for added peace of mind.



Alarm features (a world first)¹

Burglars have some nifty techniques to get into your home. Fortunately, criminals can't outsmart the **D5-Evo**. An Ambush Alarm will alert your security company if the opening or closing beams are interrupted for a predefined, but adjustable, time. Similarly, a Break-in Alarm will go off if the closing beam outside your house is interrupted. Their gig is up.

1. Requires Infrared Safety Beams to be installed



Operate wirelessly, thanks to CENTSYS²

Besides its code-hopping technology offering the highest level remote control security, this multichannel and multi-user CENTSYS onboard receiver allows for a multi-button remote to operate any combination of the system inputs, such as Gate trigger, Pedestrian Opening, Holiday Lockout, etc. The receiver stores up to 500 transmitter buttons and, amongst other access control features, it provides the ability to selectively add and delete transmitter buttons saved into its memory.

2. CENTSYS code-hopping technology

D5-EVO CONTROLLER FEATURES

Hardware features

- Fully-sealed plastic housing for controller to prevent ingress of dirt and insects
- Easy setup of controller using LCD user interface
- Removable connectors on controller for easy maintenance
- Watchdog IC ensures full and safe operation of controller
- Optional Backup Memory Module allows backing up of all the information that has been set up in the system
- **D5-Evo Low-Voltage** includes an electronic rectifier - making it the ideal cost-effective solution for sites with no mains power at the gate

Electronic features

- Opening and Closing Safety Beam/Photocell inputs with beam circuit functional test³
- High-security cleared-beam Autoclose in conjunction with safety beam (PIRAC)³
- Break-in and Ambush Alarm (a world first) with configurable outputs via onboard buzzer, Pillar Light Relay, etc.³
- Multiple Modes of Operation: Standard Mode, Condominium Mode (multi-user), Reversing Mode, PLC⁴ and Deadman Control Mode⁵
- Automatic closing with adjustable time, pushbutton override and selectable according to gate position
- Remote Gate Status Indicator (gate position, power failure, low battery, multiple collision detection and Pillar Light status indication)⁶
- Pedestrian Opening (adjustable opening and Autoclose time)⁷
- Free-exit facility⁸
- Holiday Lockout⁷ - configurable as Emergency Stop⁹
- Courtesy/Pillar Light Timer with adjustable time¹⁰
- Fully configurable pre-delays with multi-modal Pre-flash¹⁰
- Multiple Operating Profiles to suit region of installation - select between ZA, CE, etc.
- Full configuration of gate operating parameters, including independent gate opening and closing speeds, ramp-up and ramp-down distances and crawl speed
- Positive Close Mode (e.g. ensure activation of electric fence contact switch)
- Onboard multichannel CENTSYS code-hopping receiver with the ability to:
 - learn transmitter buttons to specific functions (e.g. Gate trigger, Pedestrian Opening, Free-exit, Pillar Light Control, Holiday Lockout)
 - selectively delete specific transmitters that have been lost or stolen
 - automatically learn transmitters into the system (Autolearn)
 - automatically delete transmitters that are no longer in use (Delete-Not-Present)
- Integrated ChronoGuard (a world first) with Real Time Clock and Calendar timer offering multichannel time-activated and time-barring functionality
- Auxiliary output can be configured via the ChronoGuard timer to provide timer functionality to external devices, such as security lights, entrance fountain, etc.

3. Infrared Gate Safety PE Beams or detection device must be fitted

4. PLC: separate inputs to open, close and stop the gate

5. Deadman Control Mode: separate inputs to open and close the gate, that must be held active to move the gate

6. Remote LED must be fitted

7. Onboard receiver must be used or external access control device such as keypad or keyswitch must be fitted

8. Infrared Safety Gate PE Beams or Inductive Loop Detector must be fitted

9. To use this feature, a normally-closed emergency stop pushbutton must be fitted

10. Pre-flash security/Pillar Lights must be fitted



CHRONOGUARD TIMER TECHNOLOGY (a world first)

The **D5-Evo** is so advanced that it no longer needs humans to look after it. With the CENTSYS ChronoGuard Timer Technology onboard, many of the **D5-Evo**'s features can be set to operate automatically or be time-barred at any time you choose.

Its built-in Real Time Clock and Calendar allows you to set up different exclusions, which can cater for public holidays, special Time-periods, etc.

Once you've set up the **D5-Evo**'s ChronoGuard using the intuitive LCD screen on the controller, you'll start feeling particularly redundant. For instance:



Why not automatically have your Pillar Lights switch on when the sun goes down? Let the **D5-Evo** take control. With ChronoGuard timer technology this is easy to set up and you'll never have to worry about it again.



Better still - automatically time-activate the Holiday Lockout feature when you go to bed, ensuring that only specific, authorised remotes will be able to open the gate while you're sleeping, keeping teenagers at home and unwanted 'visitors' out.

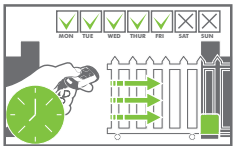

ChronoGuard gives you the ability to time-bar specific CENTSYS code-hopping remote controls. This gives you the flexibility to control when specific remote control holders can open your gate.

For example, your domestic staff may be given access to your property during the week, but on weekends you may prefer to limit their access to your property.

ChronoGuard technology allows for almost unlimited time-based functionality, all of which is very simply set up on the controller via the intuitive menu system and LCD user interface. The following functionality is available:

- Time-activate many of the physical inputs and outputs of the controller (see table below)
- Time-bar many of the physical inputs and outputs of the controller, as well as particular remote buttons learned into the onboard receiver (see table below)
- The Real Time Clock and Calendar timer has the following flexibility:
 - It supports 100 Time-periods, that may be set according to:
 - Weekdays (M + T + W + T + F)
 - Weekends (S + S) Automatic closing with adjustable time, pushbutton override and selectable according to gate position
 - Any day of the week (M, T, W, T, F, S, S)
 - Every day of the week (M + T + W + T + F + S + S)
 - Special calendar events (family holiday, etc.) occurring on any date until the year 2100
 - Annual calendar events (New Year's Day, etc.)
 - Allows for multiple Time-periods to be set during a 24-hour period
- The Real Time Clock and Calendar timer is backed up for at least one hour to maintain the current time and date in the event that all power is removed from the controller

	Physical inputs						Physical outputs	
	Trg: Gate trigger	Ped: Pedestrian opening	FRX: Free-exit	Aux: Pillar light control	Lck/Stop: Holiday Lockout	Close: Closing safety beams	Aux IO: Auxiliary output	Light: Pillar light relay
Time-activate	✗	✓	✓	✓	✓	✓	✓	✗
Time-bar Ⓞ	PHYS	PHYS	PHYS	PHYS	PHYS	PHYS	PHYS	PHYS
	✓ ✓	✓ ✓	✓ ✓	✓ ✓	✓ ✓	✗ ✗	✓ ✗	✓ ✗

Aux IO - open collector output that can be used to drive an external relay for operating any external device, eg. water feature, security lights, etc.

PHYS physical connection to an external device, eg. Inductive Loop Detector, SMARTGUARD keypad, etc

interfaces with onboard CENTSYS code-hopping receiver

ACCESSORIES

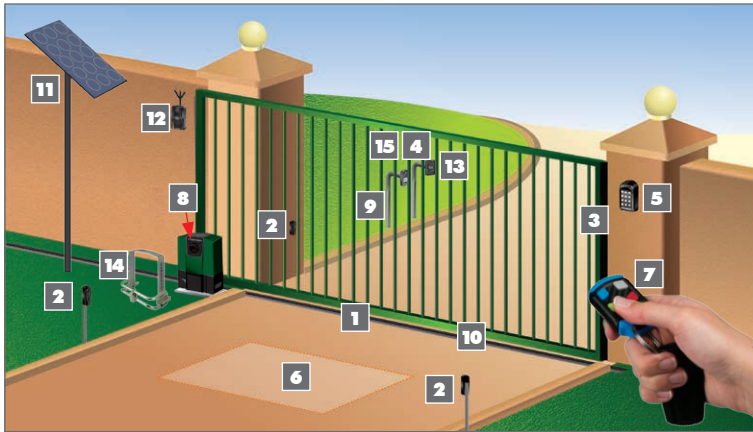

Steel-reinforced Nylon Rack
Available in 1m lengths and different strength and mounting options



CENTSYS Infrared gate safety PE beams
Always recommended on any gate automation installation



Step-down transformer
Converts high-voltage AC to low-voltage AC. The perfect power solution for your D5-Evo Low-Voltage



POLOphone intercom
Allows visitors to communicate with people inside in order to gain access to the property



SMARTGUARD or SMARTGUARDair keypad
Cost-effective and versatile wired and wireless keypad, allowing access to pedestrians



FLUX SA Loop Detector
Allows free-exit of vehicles from the property - requires ground loop to be fitted



CENTSYS transmitters
Available in one-, two-, three- and four-button variants. Incorporates code-hopping encryption



Backup Memory Module
Back up all the transmitters and operating details set up in the controller



Gooseneck
Steel pole for mounting intercom gate station or access control reader



Wheel kits
A variety of wheel kits are available from your CENTSYS dealer



Solar supply
Alternative means of powering the system - consult your CENTSYS dealer



G-ULTRA GSM device
The ultimate new GSM solution for monitoring and activating the operator via your mobile phone



SOLO/Lattice proximity access control
Proximity reader for allowing access for both pedestrians and vehicles

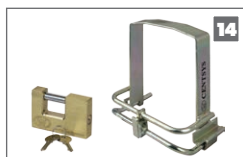

Theft-resistant cage & padlock
Retro-installable steel cage that increases the resistance of the operator against theft



G-SPEAK ULTRA
Infused with the DNA of innovation, the G-SPEAK ULTRA allows wireless communication between the user and the intercom gate station, effectively turning the user's phone into the intercom handset

TECHNICAL SPECIFICATIONS

Technical Data	D5-Evo Low-voltage	D5-Evo
Input voltage	15V - 19V AC ^{1,2}	220V AC +/-10% @ 50Hz ³
Motor voltage	12V DC	
Motor power supply ⁴	Battery-driven (standard capacity - 12V 7Ah)	
Battery charger	CP84XTE - 800mA @ 13.7V DC +/- 1%	CP84SM - 1.8A @ 13.7V DC +/-1%
Current consumption (mains supply)	60mA	
Current consumption (motor rated / peak load)	8/15A	
Current consumption (quiescent load)	75mA	
Operator push force		
Starting	30kgf	
Rated	17kgf	
Gate mass - maximum	500kg	
Gate length - maximum	100m	
Gate speed - m/min ⁴	18 - 22m/min	
Gate speed - mm/sec	300 - 367mm/sec	
Drive Pinion	17T Module 4	
Maximum daily cycle	150 cycles/day	
Design life	150 000 cycles	
Operations in standby with standard battery ^{5,6}		
Half day	70 cycles	
Full day	60 cycles	
Collision sensing	Electronic	
Operating temperature	-15°C to +50°C	
Degree of protection	IP54	
Controller incorporated	D-Series_12	
Onboard receiver type	NOVA code-hopping onboard multichannel	
Manual override	Thumbwheel behind locked door with key release	
Receiver frequency	433.92MHz	
Receiver code storage capacity	500 transmitter buttons	
Mass of unit packed	10kg	
Packaging dimensions	Length:303mm x Width: 231mm x Height: 432mm	

1. Plug-in transformer
2. Solar panel
3. Can operate off a solar supply, consult Centurion Systems for assistance
4. Varies with load
5. Can increase battery capacity for longer standby times
6. Based on 4m gate with no external accessories such as infrared Safety Beams

DUTY CYCLE

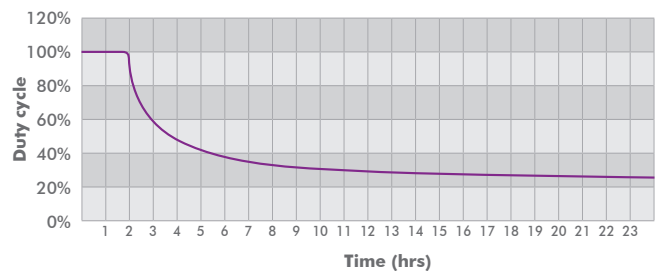

OVERALL DIMENSIONS

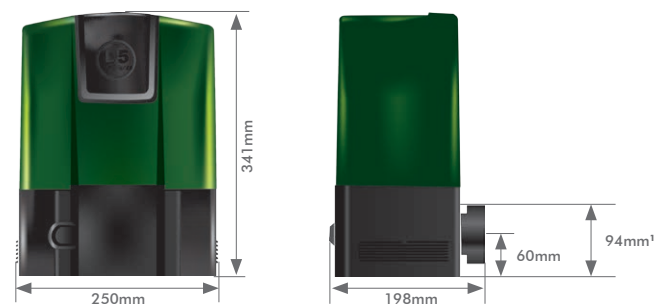

1. To the centre of the tooth mesh point of the rack